

User Manual



**TRRS**  
**ON-E**  
K I D S

20"

2021



Picture: Motorcycle only for competition and closed circuit.



**TRRS**  
MOTORCYCLES



Welcome to TRS

Dear customer,

Thank you for your confidence in us, and congratulations on the purchase of your new TRS **ON-E**.

Because of our experience, professionalism and passion for trial bikes we are able to offer you an innovative-, reliable and up-to-date motorcycle. It has a comprehensively checked technical performance that has been tried and tested both by our technicians and our high-level drivers worldwide.

The solutions we have used give the motorcycle an unmistakable character, combining simplicity, reliability and design. We pay attention to every last detail to give you a unique bike.

At the same time, this manual gives you all the information you need to use the motorcycle appropriately and safely. We recommend that you read it carefully before you use the motorcycle.

In addition, you will find tips and useful information for the maintenance and upkeep your new TRS **ON-E**.

Yours faithfully,

*Jordi Jorres*



**TRS advises you:**

Please read this user manual thoroughly before using your motorcycle. It details all the instructions for the correct handling of the motorcycle and for your safety, as well as helping towards the best possible maintenance –and upkeep from day one.

Please pay special attention to the notes flagged up with the following symbols:

**!WARNING!**

This symbol refers to points which, if ignored, could lead to some kind of damage to your motorcycle. Non-observance of these warnings could render your motorcycle warranty void.

**!CAUTION!**

This symbol refers to points which, if ignored, could lead to physical danger for the user.

**NOTE**

This symbol refers to a note. The text accompanying to a note provide you useful information or another information important about.

In addition to these specific warnings, the manual gives advice on the best use of your motorcycle, as well as better adjustment and control of its important features.

**TRS** reserves the right to make changes to this manual.



## TRS recommends:

If you have any doubts about adjustments to your motorcycle, refer to the manual and/or contact an authorised **TRS** dealer.

Please carefully read through the information in the user manual to familiarise yourself with the features of your motorcycle before driving it using the maximum power settings

- This motorcycle is designed to carry just one person, and it is not permitted to carry a passenger.
- For a long life of service, keep the motorcycle maintained as recommended– in this manual.
- This bike is designed to be safe when the driver is equipped with the appropriate safety equipment (helmet, protective clothing, etc.). Be careful and drive sensibly.



# ÍNDICE

01- Description parts.....	7
02- Technical specifications TRS ON-E kids .....	9
03- Safety responsibilities .....	10
04- CE Declaration of conformity.....	12
05- Serial number .....	13
06- Switches, Dials and Indicators.....	14
07- Drive chain .....	17
08- Suspension.....	18
09- Shock absorber .....	19
10- Brake adjustment .....	20
11- Battery use, battery care and mantainance.....	21
12- Maintenance and cleaning.....	25
13- Electrical wiring.....	27
14- Riding Instructions & safety tips .....	28
15- Limited Warranty .....	30

# 1 - DESCRIPCIÓN ELEMENTOS



- 01- Rear Lever brake
- 02- Front fork
- 03- Motor DC 48V
- 04- Shock absorber
- 05- Swing arm
- 06- Front brake
- 07- Rear brake
- 08- Charger port



- 09- Front lever brake
- 10- Chain
- 11- Sprocket
- 12- Throttle electric
- 13- Controller
- 14- Dial adjustment
- 15- Front fender
- 16- Battery

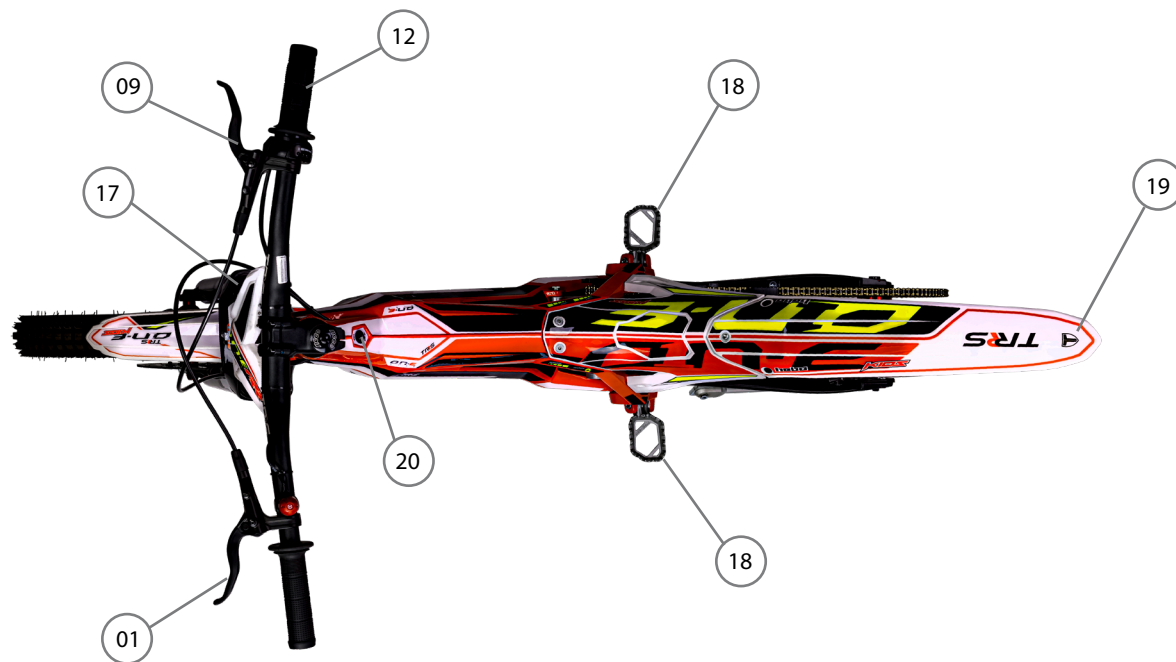

- 17- Adjustment front suspension
- 18- Footrests
- 19- Rear fender
- 20- LED Indicator



## 2 - TECHNICAL SPECIFICATIONS TRS ON-E

### PERFORMANCE

Maximum Speed	25 Km/h
Autonomy	Until 3h
Weight Limit Rider	35kg

### CHASSIS

Frame & Swing arm	Alloy Aluminium (Red)
Front Suspension	Telescopic air fork, 26" adjustable rebound / 100mm stroke/ Ø32mm aluminium
Rear Shock absorber	Spring & oil type, adjustable rebound
Connecting links	Progressive sistem links TRRS
Front Wheel	Rebel XBIKE trial 20x2.5
Rear Wheel	Rebel XBIKE trial 20x3
Brakes	Clarks M2 Hydraulic brakes
Footrests	TRRS grip footrests. Adjustable (+/-) 2.5mm

### MOTOR

1350 W 48V magnet DC motor

### GEARING

11T Front Sprocket / 86T Sprocket / 219 Chain

### CONTROLLER

Adjustment controller in three terms: Power, Speed & Response.

### THROTTLE

Twist type with LED battery charge indicator.

### BATTERIES

48V lithium with capacity 17,5 Ah

### CHARGER

Lithium AC90V-260V DC54.6V 4,5A

### SWITCH & DIALS AND PORTS

Switch ON /OFF

Adjustment controller: Power, Speed & Response

Kill switch

Charger port

### DIMENSIONS & WEIGHT

Maximum Length	160cm
Seat Height	56cm
Ground clearance	28cm
Handlebar Height	89cm
Weight	24,7 kg

**Note:** There are many factors effect speed and range capabilities. Terrain, avarage, speed, rider weight, tire pressure, wind, hills, etc.

## 3 - SAFETY RESPONSIBILITIES

Always follow the Pre-Ride Checklist before every ride.

Do not operate your **ON-E** if any damage is apparent. Immediately contact your local retailer/distributor or **ON-E** Customer Service.

**1. SUPERVISION:** Riders must be supervised by responsible adults at all times. The rider should never be beyond eye and voice range. An adult must ALWAYS assess and approve the riding conditions and the bike preparedness before the bike is ridden. Always ensure the rider is cautious, maintaining complete control and a reasonable speed. Ensure the terrain is suited to the skills of the rider.

**2. HELMETS & SAFETY ATTIRE:** There is no single factor that works better at reducing the severity of injuries sustained in accidents more than a quality helmet. Please don't ever allow your **ON-E** to be ridden without one. Riders should also wear suitable riding gear - gloves, eye protection and boots. Boots should not have laces. Shoe laces and loose clothing or even long hair could potentially get caught in wheels, chains or sprockets.

**3. ONE RIDER ONLY:** Your bike was engineered to carry one rider and no passengers. Carrying a passenger would overload the machine and alter the handling. Do not allow this to happen.

**4. DON'T OVERLOAD THE BIKE:** These motorcycle are designed for small, lightweight riders. Exceeding the weight limitations will adversely affect the handling of the machine, and potentially cause damage.

**5. CONDITIONS OF USE:** This motorcycle is limited to use only OFF-ROAD. This means that this motorcycle cannot move on streets or public roads, as well as on sidewalks. The owner of the motorcycle, is responsible for complying with this standard and others that the state where the on this type of machines resides.

**6. VISIBILITY CONDITIONS:** Do not ride the motorcycle, when the light conditions significantly reduce visibility. Attention at sunrise or sunset even with fog or cloudy sky. Keep in mind that this motorcycle is not equipped with position lights.

**7. ADVERSE WEATHER CONDITIONS :** When the ground is wet, the adhesion of the wheels with the ground, as well as the effectiveness of the brakes, lose efficiency. For this reason it is important to know that driving should be much smoother than in dry situations, as the braking distance increases, as well as the danger of skating and causing a fall. It is advised not to drive when it is raining or snowing. Take into account these conditions on flat terrain and especially on steep ups and downs.

**8. MAINTENANCE:** Follow the maintenance of the motorcycle, it is important to extend the life of the motorcycle, as well as ensure that the operation is correct and safe. Follow the instructions in this manual. Before each use, check the operation of the brakes, condition of the tires and tighten the related screws.

It is recommended that the motorcycle be checked by a TRS service, at least once a year.

**9. BATTERIES:** Our motorcycles are equipped with lithium-ion batteries. The location of the battery on the motorcycle protects it from possible shocks and gives it the necessary tightness. Review this manual to find more specific information on this aspect.

**10. READ THIS MANUAL:** Leer este manual por completo para conocer las características y peculiaridades de una moto eléctrica. Si tiene alguna duda que no lo resuelve en este manual, no dude en contactar con su distribuidor TRRS local. Puede consultar en la página web [www.trsmotorcycles.com](http://www.trsmotorcycles.com) el distribuidor que le queda más cercano.



## SUMMARY

- 1. SUPERVISION:** A responsible adult must supervise at all time.
- 2. WEAR A HELMET & SAFETY GEAR:** The rider must wear a helmet & appropriate safety gear every time.
- 3. NO PASSENGERS:** It is totally forbidden to carry passengers.
- 4. DO NOT EXCEED THE WEIGHT LIMITATIONS OF THE MACHINE.**
- 5. CONDITIONS OF USE:** OFF-ROAD
- 6. VISIBILITY CONDITIONS**
- 7. ADVERSE WEATHER CONDITIONS:** The terrain may vary, so be responsible.
- 8. PLEASE MAINTAIN YOUR BIKE.**
- 9. CARE FOR YOUR BATTERIES**
- 10. READ, STUDY AND UNDERSTAND THIS ENTIRE MANUAL.**
- 11.** If you don't understand any aspect of the use and care of your bike, please call TRRS customer service.

# 4 - CE DECLARATION OF CONFORMITY

**PRODUCT DESCRIPTION:** Kids Electric Motorcycle Off-Road

**MODEL DESIGNATION:** ON-E KIDS

**YEAR OF MANUFACTURE:** 2020

**SERIAL NUMBER :** XXXXX

**Comply with::**

Electrical safety tests on the charger battery according EN60335-1:2008 y EN 60335-2-29:2004 (Low Voltage Directive 2014/35/CE).

Safety for batteries and secondary cells IEC/EN 62133-2:2017.

EMC according to standards EN 55014-1:2017; EN 55014-2:2015; EN 61000-3-2: 2018; EN 61000-3-3:2013 +A1: 2017 (Directive 2014/30/EU).

**The following standards have been applied:**

Mechanical Technical examination of conformity to the Machine Directive 2006/42/EC drawn from the EN-16029:2012 standard.

**Technical documentation filed at:**

TRS MOTORCYCLES, S.L.  
C/ Muntaner 292 planta 3 puerta 2  
08021 Barcelona (España)

**Position:** Technical director

**Signature:**



Marked CE located on the head tube

## 5 - SERIAL NUMBER

All motorcycles that manufacture in **TRS** come out with an identification number engraved on the frame and that appears in the technical file of the documentation that we deliver to the user. This number cannot be replaced or modified under any circumstances. This number is located at the bottom of the chassis, under the engine at the rear and may be required in any technical inspection.



**¡WARNING!**

It is advisable to keep the serial number and identification information of your motorcycle noted to expedite procedures in case of theft or supply of spare parts.

### SERVICE / WARRANTY

If there is a need to make a warranty claim, it must be processed by an authorized **TRS** dealer. (See the Warranty page 31)

For any questions about your **ON-E**, please contact a local distributor or seller.

You can check the list of distributors and contact information at [www.trsmotorcycles.com](http://www.trsmotorcycles.com)

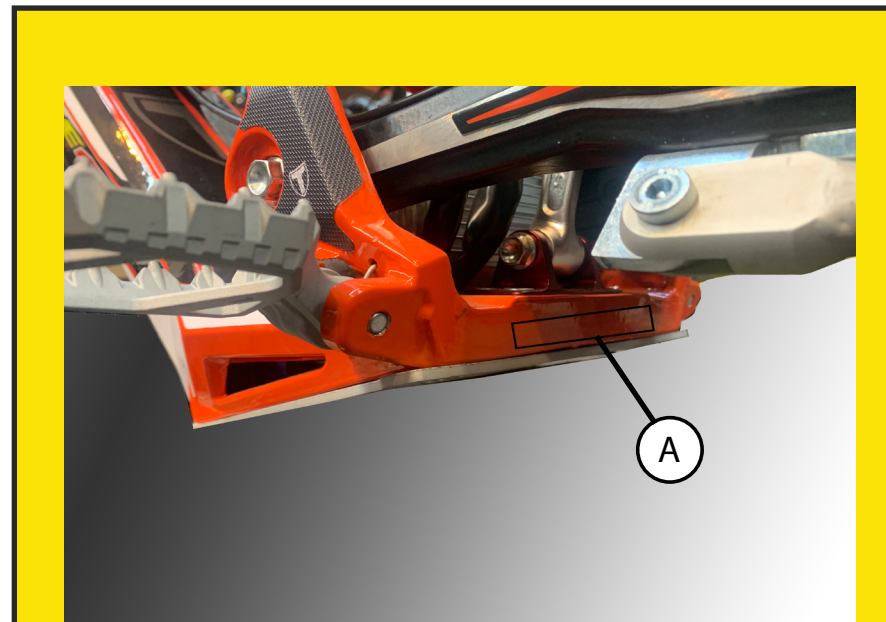

**A)** Located at the bottom of the chassis, under the motor at the rear

## 6 - SWITCHES, INDICATORS & DIALS

### SWITCH ON/OFF

The (ON / OFF) switch allows you to turn the motorcycle on and off. The button is located on the chassis. Figure (A).

### KILL SWITCH

This switch is connected in series with the switch on/off. The kill switch must be in place for the switch to be in the on position.

It is a safety element, so that, in the event of the pilot falling, the motorcycle is disconnected. Make sure that the rider puts the elastic band on the left wrist and is firmly secured, before starting the motorcycle.

With this switch you can also turn the motorcycle on and off, placing the red part on the base placed on the left side of the handlebar. It also has the function of anti-theft or use without consent, disconnecting the red part of the base and saving it in another place.

**!CAUTION!**

If the accelerator is applied before connecting the kill switch, the motorcycle will not move.

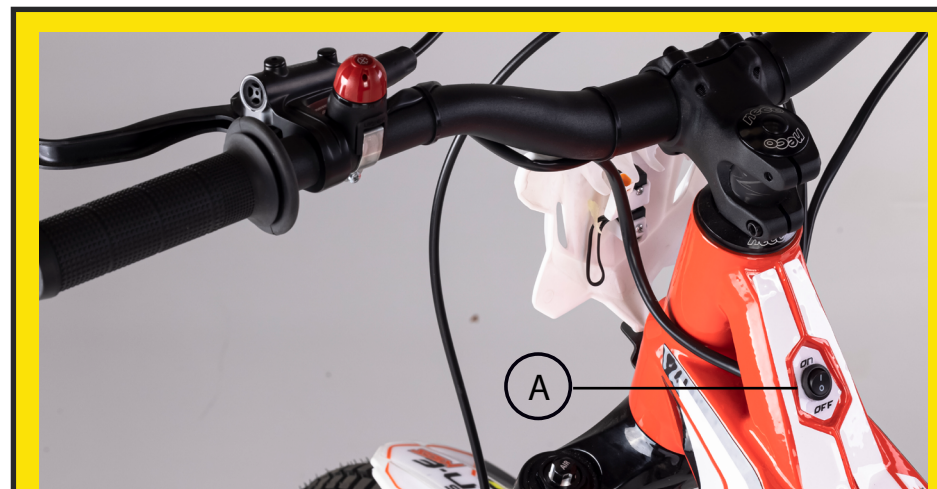

Figure A) Switch ON /OFF locates on the chassis



Figure B) Kill switch, put the elastic band on the left wrist

## DIALS: POWER, SPEED AND RESPONSE

The motorcycle allows you to adjust the parameters to adapt the motorcycle according to the skill of the rider, as well as the off road conditions. There are 3 dials are located on the inside of the chassis, under the seat.

### 1. SPEED (Blue)

Increase or decrease top speed. For beginners it is recommended to start with the minimum.

### 2. RESPONSE (Red)

Increase or decrease the sensitivity of the gas. At a minimum the gas reaction is slower. At maximum, the gas response is faster. For slippery surfaces and / or for beginners, a low setting is recommended.

### 3. POWER (Yellow)

When the power increases, it allows to get more torque uphill and obtain faster reactions as well as. The maximum adjustments is only recommended for more experienced pilots.

## PLEASE NOTE THAT:

DIALS SHOULD BE ADJUSTED ONLY BY AN ADULT RESPONSIBLE AND KNOWLEDGE OF THE SKILL OF THE RIDER AND OFF ROAD CONDITIONS.

It is recommended to start with all the dials to the minimum and depending on the skills of the pilot to increase the regulation. Take note of the found properly setting.

To become familiar with the adjustments and visualize the effect of each dial, it is advisable to place the motorcycle on a stand and become familiar with the reactions of the motorcycle.

## NOTE

Prolonged use of the adjustments in the maximum position can significantly reduce the autonomy compared to the adjustment in minimum positions.

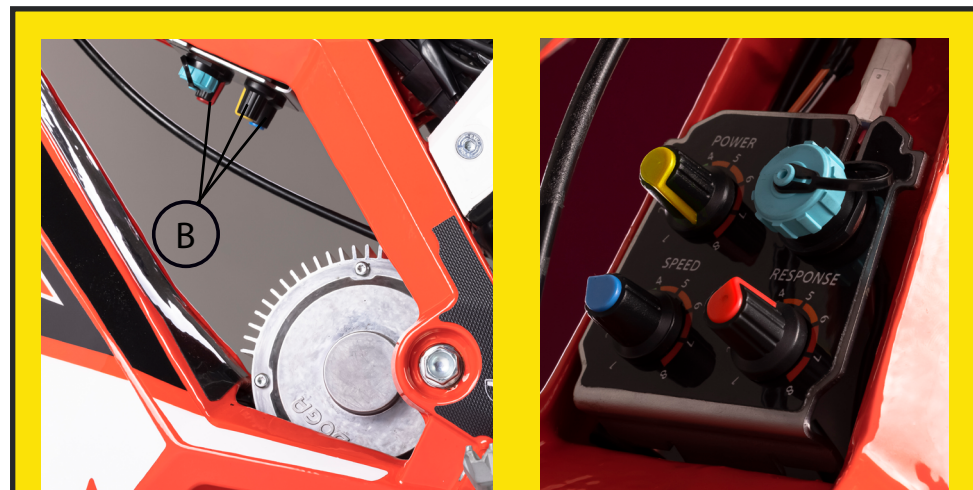

Fig B) Dials are located inside of the chassis. This allow to set: power (yellow), speed (blue) and response (red). Turning the adjusters clockwise, the performanc of the motorcycle increases. On the contrary direction, turning counterclockwise the performance is reduced to a minimum.

## !CAUTION!

The regulators are sensitive to small adjustments. Don't guess the changes. Always check beforehand that the settings made are correct for the pilot's skills.

**!WARNING!**

It is very important to keep everyone at a distance when the motorcycle is charging or the dials are being adjusted. Dials are sensitive to small adjustments. Don't guess the changes. Always check beforehand that the settings made are correct for the pilot's skills.

**CHARGE INDICATOR**

The battery charge indicator is integrated into the throttle and indicates the charge of battery. This indicator also indicates whether the power switch is off or on. Always turn off the switch when the motorcycle is not used.

As the battery charge depletes, the lights of indicator will be off. When all 4 LEDs are on, it means full charge. As the load decreases, the LEDs turn off. When only 1 led remains on, it indicates that the battery charge is low.

To extend the autonomy, it is recommended to choose positions of lower power, speed and response as the charge decreases. When only one red LED is lit, it is recommended to charge the ON-E as soon as possible. In this way, it is possible to extend the life of the battery when is not consuming its charge to the maximum.

When the motorcycle do not used, the motorcycle must be disconnected, turn off the switch.

**NOTE**

During use, it can be seen that the indicator depletes, when the maximum power is required, this phenomenon being normal.





## 7 - CADENA DE TRANSMISIÓN

This motorcycle uses a chain of transmission, drive sprocket and rear sprocket common in a motorcycle of greater size. This motorcycle has no gears, it is direct transmission from motor to wheel.

The chain must be checked before every ride and adjusted as necessary. There should be very little slack in the chain. Adjustment is done as follows:

1. Ensure power is turned off. Switch OFF and kill switch disconnecting.
2. Unscrew the rear wheel axle until the wheel is free from tilting. Don't remove the shaft.
3. Chain tensioning procedure:
  - a) Unscrew the locknut with wrench 8mm between swingarm and wheel tensioner. There is one on the right side and one on the left side.
  - b) Unscrew the screw with wrench 8mm by pushing the chain tensioner. With little twist, the displacement is large. Perform the operation symmetrically. Do not leave the chain too tight, keep in mind that when the shock absorber is compressed, the chain tends to tighten.
  - c) Check that the rear wheel is aligned with the swingarm.
  - d) Fix the locknuts on both sides.
  - e) Screw the rear wheel axle.

f) Check the drive sprocket and rear sprocket screws are correctly tightened.

g) Lubricate the chain with chain spray. **TRS** recommends the use of NILS Off road chain.



Unscrew the rear wheel axle with a 8mm Allen wrench.



Unscrew the chain tensioner with a 8mm wrench by pushing the chain tensioner. Perform the same operation on the other side of the swingarm. Fix the locknuts and screw the wheel axle. Check that the drive sprocket and rear sprocket screws are correctly screwed.

## 8 - SUSPENSION

This motorcycle is equipped with pneumatic suspension, to the front and rear adjustable.

### FRONT SUSPENSION

Possible settings are:

**A) Compression:** Adjustable with the knob, located on the top of the right bottle. By turning the compression dial counterclockwise we can block the damping completely or harden it, if we turn the dial clockwise we unlock the compression.

**B) Rebound:**

The rebound adjuster is located on the bottom of the right bottle. Turning counter clockwise we get a faster bounce, otherwise clockwise the rebound is slower.



B) Rebound

A) Compression

The front suspension is an "air" fork. A specific air pump is required to add pressure. The air pump is not supplied with the motorcycle.



We can adjust the hardness or smoothness of our suspension with an air pump.

## 8 - REAR SHOCK ABSORBER

This motorcycle is equipped with an oil damper with coil spring located at the rear. The shock absorber is connected to a system of connecting links that confers progressivity in the travel, that is to say in the first part of the travel the damping is soft and while in the final part the damping hardens. This allows to increase the traction in the first course and reduce the impact when the motorcycle makes a jump.

The shock absorber has the possibility of two adjustments:

**A) Spring preload.** By adjusting the nut that holds the spring, the force of the spring can be hardened or softened. By turning the nut clockwise, more hardness is achieved, while turning counterclockwise, more smoothness is achieved.

There is another replaceable spring with different hardness as an accessory, to get a better fit depending on the weight and skills of the pilot.

**B) Rebound.** There is a knob on the top of the shock absorber. It is under the saddle. By adjusting this parameter, the shock absorber can recover the position after compression, faster or slower. In the clockwise direction the rebound is fast while in the counterclockwise direction the rebound is slow.

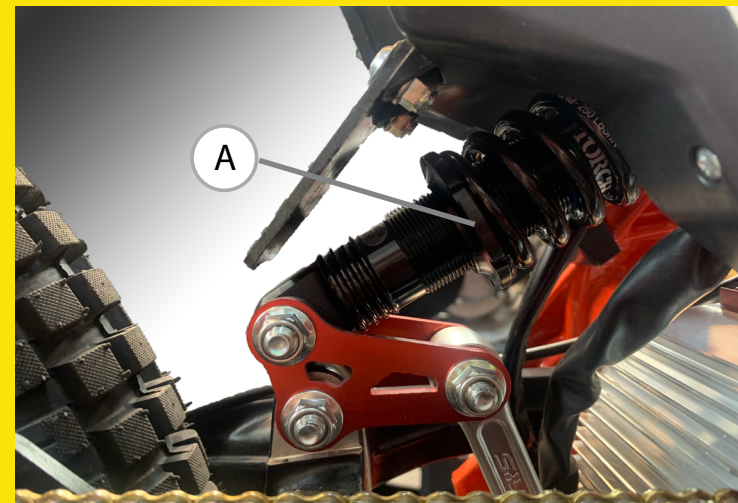

A) Spring preload

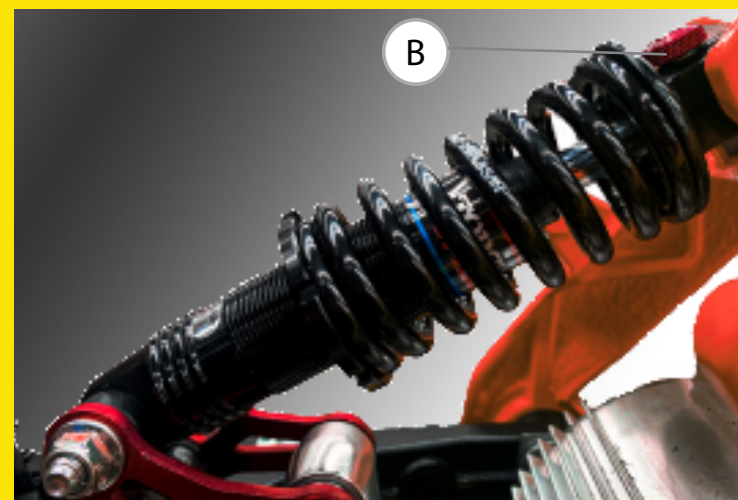

B) Rebound

## 09 - BRAKES

To ensure optimal braking it is necessary to check the condition of the brake pads: initially they usually have 3mm of ferodo. If after its operation we observe that this distance has been reduced below 2mm, it will be necessary to replace them with new ones.

To replace it is necessary to disassemble the front brake from the suspension bottle, removing the screw and the clip that are removed from the bottom. For assembly it is necessary to open the pistons with a screwdriver by prying between them to separate the pistons. In turn, you must ensure the tightening of the screws and pin.

The brakes are self-adjusting to a point, but their correct alignment guarantees maximum performance. The pads should keep the same distance from the disk for maximum efficiency.

Visually inspect the pads while the wheel is spinning. Check that your alignment is correct and keep the same distance from the disc. If you need to make any adjustments, follow the instructions below:

1. Remove the safety clip from the screws. There is one on each brake.
2. Using the 5mm allen wrench, loosen the two screws on the brake bracket, allowing the caliper to move freely.
3. With the wheel raised, act on the brake lever, this will move the caliper to the center with respect to the disc.
4. While still acting on the brake lever, the pads firmly tighten the disc, without releasing the lever, re-tighten the two caliper bracket screws.
5. If the wheel doesn't turn freely after stopping the brake, further adjustment is

required beyond the limits of the caliper's own adjustment that can be achieved using spacer washers. In this way the clamp can align perfectly.

6. Put again the screw security clip. There is one in each clamp

7. The brake levers can be adjusted in range. Use a 2mm Allen. Turning the screw counterclockwise manages to bring the reach closer to the handlebar (for smaller hands)

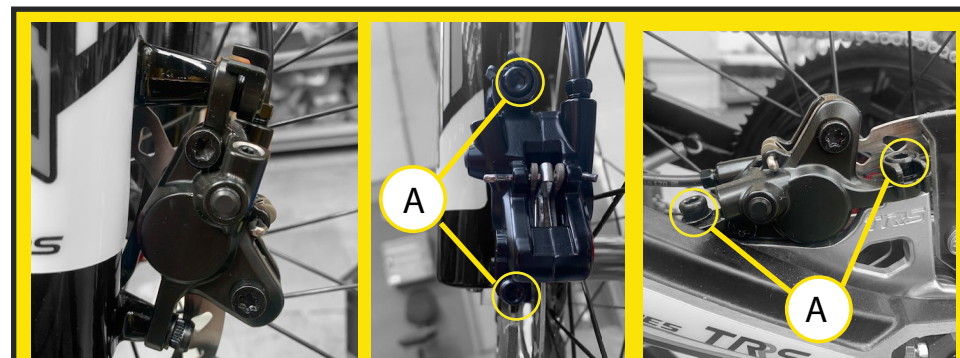

Using the 5mm Allen wrench, loosen the two screws on the front and / or rear brake caliper.

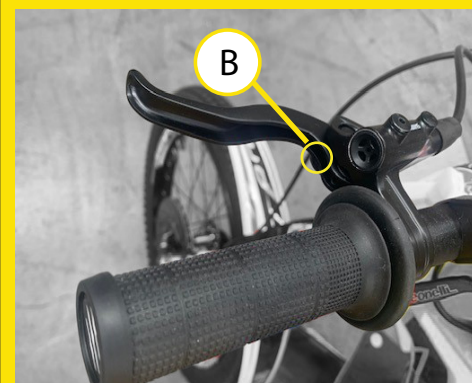

The brake levers can be adjusted in range, using a 2mm Allen and turning the screw in one of the directions we can adjust the range we want.

## 10 - BATTERY USE & MAINTENANCE

For the use, maintenance and storage of batteries, it is of crucial importance to read and understand the instructions in this manual.

### !WARNING!

Improper use, charging and storage of batteries will invalidate the warranty, and may cause a dangerous situation. Do not use these batteries in any other vehicle or device. The use of these batteries in any other product will void the warranty and may create a hazardous situation that could cause a fire and serious injury.

If you have any questions about the batteries and your use, do not hesitate to contact **TRS** Motorcycles customer service.

### !CAUTION!

Keep the battery away from excessive heat and/or open flames. A void long term exposure to direct rays from the sun.

### !CAUTION!

Protect the batteries from the water or other moisture. If the batteries become wet from rain during use, dry soon as possible. Remove the batteries from the bike before washing.

### !CAUTION!

To avoid damage to the battery, never subject it to intense physical shock or severe vibration.

## CHARGING INSTRUCTIONS

1. Ensure power is turned off, and the kill switch is disconnecting.
2. Before to connect the charger connector in the power, first connect the charger pin on the motorcycle.
3. Under the seat , you will find the charger connector. Remove the connector cap and carefully align the connector pins and connect the charger to the battery by plugging the connector into the charger receptacle. Twist the lock ring to secure the charger lead to the bike.
4. Plug the charger into the wall outlet electric network.
5. LED indicators:
  - LED OFF: Not connected to the electric network
  - Green LED slowly flashing: Connected to the electric network
  - Green LED faster flashing: Charging.
  - Green LED fixed: Charge completed.



#### Charger:

- LED OFF: Not connected to the electric network
- Green LED slowly flashing: Connected to the electric network
- Green LED faster flashing: Charging.
- Green LED fixed: Charge completed.

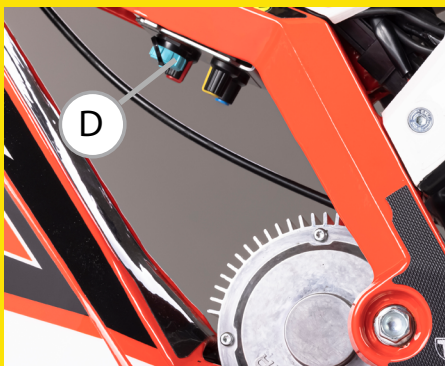

Under the seat , you will find the charger connector. Remove the connector cap.



Put in the correct position the three-pin plug (fig F) aligning the white dot with the protrude from the charging connector (fig E). Screwed in the nut that brings the three-pin plug (fig D). Replace the blue cap when the battery is fully charged.



Fig E) Charger connector

Fig F) Three- pin plug



When the battery is complete (the indicator LED is GREEN), then unplug the charger from the wall socket, then from the battery by twisting the lock ring and pulling the connector out of charging port.

Normally takes four hours to charge your batteries from a fully discharged condition. Never overcharge. Remove the charger after 5 hours maximum. It's recommended that you fully charge the battery before & after every ride. Never left the batteries discharged for a long period of time.

**!CAUTION!**

Don't cover the charger while the battery is charging. This could cause overheating on charger.

**!CAUTION!**

The battery charger supplied with this battery is for INDOOR use only.

**!CAUTION!**

Avoid any contact with water or other fluids while charging the battery. If the battery, charger or any connections become wet, immediately unplug the charger and thoroughly dry all components prior to charging the battery.

## BATTERY REPLACEMENT

As an accessory, there is the possibility of acquiring an extra battery, to be able to change in case the battery runs out and you want to continue driving. Check the following procedure:

1. Ensure power is turned off, and the kill switch is disconnecting.
2. Lie down the ON-E on the ground carefully.
3. With a 5mm allen wrench, take off 4 screws of the skid plate.
4. Unplug the connector from the battery twisting the lock ring and pulling the connector out.
5. With a 8mm drive metric sockets, remove the 4 screws of the plastic cover battery.
6. Carefully remove the battery.
7. Assembly the other battery and follow the instructions in the opposite order.



Put your ON-E on the ground and with a 5 mm Allen wrench, remove the 4 screws from skid plate of the chassis and unplug the connector from the battery twisting the lock ring counterclockwise.

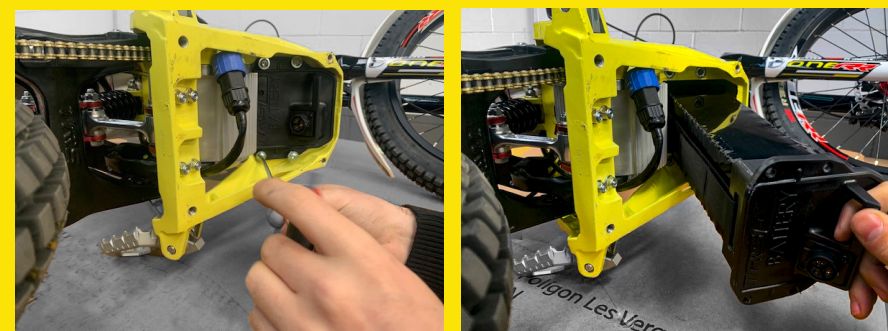

Then remove the screws from the plastic cover battery with a 4mm drive metric sockets and remove battery.

## LONG TERM STORAGE

If you do not use your ON-E for an extended period of time ( 1 month or more), remove the batteries from the bike for storage. TRS recomend you follow the steps:

1. Fully charge the batteries before storing.
2. Disconnect the battery, following the steps:
  - 2.1 Ensure the **ON-E** is disconnect.Ensure power is turned off, and the kill switch is disconnecting.
  - 2.2 Put your **ON-E** down on the ground carefully.
  - 2.3 With a 6mm allen wrist, take off 4 screws of the skid plate from chasis.
  - 2.4 Unplug the connector twisting 1/4 the lock ring counterclockwise.
3. Fully recharge the batteries at least every 60 days of storage.
4. Store the batteries in a cool, dry place. Avoid direct exposure from the sun.

If you have any questions about batteries or their usage, please do not hesitate to contact your local dealer or the **ON-E** Costumer Service Department.

## !WARNING!

Use only the supplied battery. If you use any other battery charger, you will void warranty, you may damage the batteries and you could cause a fire that would result in property damage and possible injury or death.

## IMPORTANT NOTES ABOUT BATTERIES

1. Normally takes five hours to charge your batteries from a fully discharged condition. Never overcharge. Remove from the charger after 5 hours maximum.
2. Fully charge the batteries before using your **ON-E** For the first time. 5 hours maximum.
3. Fully charge the battery before & after every ride.
4. Always disconnect the AC power source from the wall socket before disconnecting the charger from the bike.
5. Always connect the charger to the bike before connecting the charger to the AC power source.
6. To avoid damage to the charger, never subject it to intense physical shock or severe vibration.



# 11 - MAINTENANCE & CLEANING

## DAILY MAINTENANCE

1. Keep your **ON-E** clean and dry. Clean using the recommended procedure.
2. Check all components for tightness and adjustment, including handlebars, levers, axles, chain, brakes.
3. Check the tires for proper inflation. Also, inspect the tires for damage.

PROPER INFLATION	
Front Wheel	0,5 - 0,6 kg/cm <sup>2</sup>
Rear Wheel	0,7 - 0,8 kg/cm <sup>2</sup>

4. Check the speed, power and response setting before each ride.
5. Check the wheel spokes for tightness. It is normal for spokes to loosen in operation. PLEASE CHECK after every initial ride, and then regularly afterwards. If you need guidance please consult a skilled wheel builder or call **ON-E** customer service.
6. Periodically check the tightness of motor primary gear screw.

You can use waterproof grease around the primary sprocket for additional protection from the elements.

## CLEANING

Cleaning and maintaining your **ON-E** correctly will provide a more enjoyable ownership and riding experience. We recommend cleaning be done with a damp cloth and running water. While you cleaning the bike by hand, you can simultaneously inspect all of the components.

Care must be taken when washing. This is an electric machine and water should never reach sensitive components. Never use a power washer as it may cause irreparable damage to sensitive components.

If a hose is used, cover sensitive parts.

### !WARNING!

Water and electrical components do not mix! Do not get water onto the controller, throttle or wiring. Failure to follow this instruction could result in permanent damage, and could cause erratic machine behavior, leading to possible injury or death.

## 12 - ELECTRICAL WIRING

Your **ON-E** is an electric bike, and features a considerable number of electrical components and wiring. All must be protected from water and dirt!

The components are listed below:

**Controller:** This electronic element, is the brain of the drive system. It is powered by the battery and responds to the position of the gas fist. It is turned on and off by means of a switch On /Off or kill switch.

**Engine:** The motor is the end of the line where the power is actually delivered. The motor is made up of many components. Any servicing must be carried out by trained technicians only. Please do not attempt to separate or dismantle the motor in any way.

### !WARNING!

Be careful, the engine increases its temperature with the use of the motorcycle. Do not touch its surface, it could cause burns.

**Battery:** This element contains the energy to move the motorcycle. The battery is 48V. therefore, a cautious and responsible use is recommended.

**Throttle:** This sends an electronic signal to the controller, wich is then interpreted to determinate the power required. The throttle contains a small circuit board that can be damaged by water. Similarly, the connection between the throttle and controller must be protected from water at all times. It must be protected from water.

### !CAUTION!

Ensure that the throttle control is in the correct position. For user safety it is important that the throttle works freely when turned to accelerate and check that it is not blocked. In case you have to do some repair you have to leave a distance between the end of the handlebar and 1.5 mm throttle knob.



Check the assembly distance between the end of the handlebar and the throttle control. It must be 1.5 mm to prevent its block with the end of handlebar caps.

There are other components that confer the electrical wire, such as: ON / OFF switch, charging connector, dial adjustment and wiring.

# ESQUEMA ELÉCTRICO

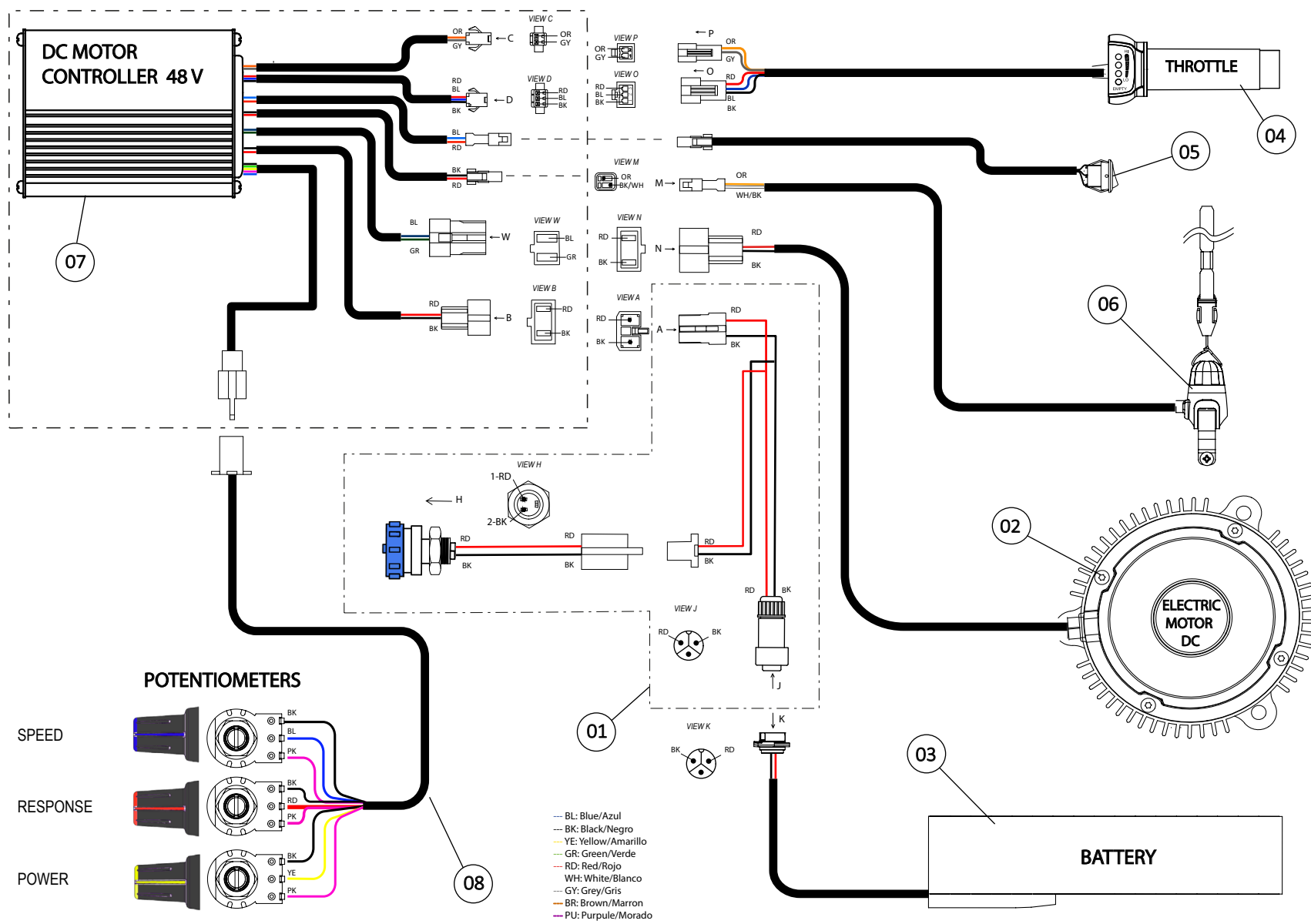

## 13 - RIDING INSTRUCTIONS & SAFETY TIPS

With the bike set up correctly, your ON-E is ready to ride! For learning riders, please use these tips and instructions. The riders will get the most enjoyment if they feel safe and in control. Do not be tempted to start the riders too quickly. Make sure the dial adjuster are set to their slowest settings to begin (Position 1. Beginner)

### ¡ATENCIÓN!

Do not exceed the abilities of the rider! Only allow competent riders with full instruction to ride the bike. Do not allow inexperienced riders on the bike before they have demonstrated a complete knowledge of the controls. Always start on the slowest settings.

### STATIONARY LEARNING

1. Ensure the switch is in the off position
2. Lift the machine on to a stand or block so the back wheel is an inch or two off the ground. Ensure the bike is stable and cannot be rocked or fall off the stand.
3. Sit the rider on the machine.
4. Explain all the controls:
  - A. Throttle
  - B. Front Brake (right hand side).
  - C. Back Brake (left hand side).
5. Have the rider practice each control, while the power is still off.

6. Once rider have been practiced, with the motorcycle stopped, explaining how the motorcycle is turned on and what function the kill switch.

7. With the rider on the bike place the rider's feet either on the pegs, or on the ground and hands on the handlebars, turn on the switch.

8. For learning riders, Make sure the dial adjuster are set to their slowest settings to begin (position 1) The riders will get the most enjoyment if they feel safe and in control. As the pilot increases skills, will be able to change the map gradually, going step by step.

9. At this time, have the rider practice opening and closing the throttle and, as well as the reaction of the motorcycle. The aim is to get some throttle control, and not use it as an 'on-off' switch. This is very important.  
DO NOT RIDE UNTIL THIS HAS BEEN LEARNED FULLY.

10. While still practicing the throttle, practice using the rear brake to stop the back wheel. Make sure that this is coordinated. The throttle and brake should not be applied simultaneously.

11. UNTIL THESE SKILLS ARE MASTERED, DO NOT LET THE CHILD RIDE THE BIKE!

### NOTA

If the rider does not fully understand the controls and demonstrate these skills, do not let them ride. They can try again at a later date when they are ready. The riders must learn at THEIR pace.

## FIRST RIDE

After the rider understands the controls and is comfortable with them, it's time for the first ride. For this, the rider must be dressed correctly in suitable safety gear. Boots, gloves, a helmet and eye protection are necessary.

The venue must be flat, open and safe, with no obstacles of any kind. The machine must be set up correctly, with the speed set to its lower setting and the throttle response set to its lowest.

1. Ensure the power is turned off.
2. While an adult supports the bike, the rider can get on.
3. The rider now can reach back with their left foot, and put the side-stand to the up position. Have an adult ready to hold the bike up for this!
4. Encourage the rider to rock the machine from side to side and forward and back, in order to get comfortable with the weight of the bike.
5. The rider can now switch the machine on.
6. Before turning the throttle, the rider's legs can be splayed forward and out like outriggers.
7. The rider can now twist the throttle (as slowly as possible) and go. Encourage them to go and stop, go and stop... using the brakes to stop. Have a supportive hand on the rear fender whenever possible.
8. Once comfortable, the rider can try to ride along and lift their feet onto the pegs as they go.

9. When stopped, turn the power off.

### !ATTENTION!

OFF ROAD USE ONLY!

**ON-E** are designed for off road use only and must not be used on public roads or sidewalks. Please check and obey all local laws.

### !CAUTION!

If the rider drops the bike, ensure that the power is turned OFF before lifting the bike. It is good practice to turn the power off whenever there is no rider on the bike..

## 14 - WARRANTY

### TRS MANUFACTURER WARRANTY CONDITIONS

These terms and conditions are in accordance with the regulation in Law 23/2003 of 10th July of Warrantees in the Sale of Consumer Goods.

TRS guarantees the buyer (hereinafter referred to as the “Customer”) a vehicle manufactured by TRS to the highest quality in materials and production, delivering a product free from any defects. Therefore, TRS will guarantee the customer the repair free-of-charge of any defect in material or production identified in a new vehicle while the relevant warranty term is still in force and without taking into account the number of kilometres travelled or the number of operating hours of the vehicle.

### EFFECTIVE PERIOD

It is considered that the warranty is effective from the day of delivery of the product to the Customer, or from the day on which the vehicle is used for the first time in the case of demonstration models. The seller shall be liable for the possible faults or defects of their product during the period established in Law 23/2003 of 10th July of Warrantees in the Sale of Consumer Goods from its delivery and in accordance with Directive 1999/44/EC for the other Member States of the European Community (outside the European Community the warranty period defined by the regulations in force in each Member State will apply). Note that any failure or defect of the product that occurs in the first six months after its delivery shall be considered as an existing initial defect and after the sixth month, the Customer must prove that the defect existed at the time of delivery. In the event that the warranty period ends on a Sunday or a public holiday, it will be extended to take in the following working day. The warranty shall only cover any claims made for defects during the effective period of the warranty.

### REQUIREMENTS TO PUT THE WARRANTY INTO EFFECT

TRS reserves the right to reject warranty claims if:

- 1)** The vehicle has been incorrectly transported or stored, by not following the manufacturer’s recommendations.
- 2)** The vehicle has been used competitively, pushing it beyond its normal operating limits.
- 3)** Parts and/or any kind of service fluids unauthorised by the manufacturer have been used as substitutes in vehicle service or repairs.
- 4)** The services or maintenance required for correct operation of the vehicle have not been performed within the effective warranty period or, if faults have appeared prior to the date of a required service, it has not been carried out, or has been carried out after the established time frame.
- 5)** Any service or maintenance operations have been carried out by persons unauthorised by TRS.
- 6)** Any repair or maintenance work carried out that does not comply with the requirements specified for that operation by TRS.
- 7)** The vehicle or any part thereof have been modified without the authorisation of TRS.
- 8)** The vehicle has been damaged through misuse and/or an accident.

## PARTS OR ITEMS CONSIDERED OUTSIDE THE WARRANTY COVERAGE

- 1) Maintenance operations and cleaning of the vehicle.
- 2) Any kind of service fluids (coolants, lubricants, etc).
- 3) Noise or aesthetic defects which do not affect the use of the vehicle (such as marks or damage in inconspicuous areas, noises without any important mechanical consequences, etc.).
- 4) Damage to the bodywork due to external agents (extreme environmental conditions, impact from objects, etc).
- 5) Additional costs resulting from the defects themselves (transport costs, cranes, costs of replacement vehicles, lodging, etc).
- 6) Wear of paint or plastic due to the passage of time.
- 7) All kinds of parts subject to wear and tear due to their use (batteries, filters, discs or brake pads, tyres, etc).

## OTHER CONSIDERATIONS

- I) The right is reserved to request assessment by a TRS expert if there are any doubts regarding the need to repair a defect during the warranty.

The warranty covering the spare parts will end on the date of expiry of the warranty period of the product concerned.

- II) TRS reserves the right to decide whether to repair or replace the parts in a warranty claim.

III) In the event that there is a defect that cannot be repaired or where it is difficult for the company to provide a replacement, the customer shall be entitled to compensation due to the termination of the contract or to the partial refund of the price paid for the vehicle.

IV) The guarantee offered by TRS as manufacturer does not include claims on aspects related to the sale of the vehicle that are exclusively concerned with the dealer offering the product. These claims must be addressed directly to the dealership.

V) The warranty coverage shall be for the period established by the manufacturer, regardless of whether the vehicle is resold to another user during that time. The new user will have the same warranty conditions until the expiry of the period determined from the date of the first sale.



**TRS**<sup>®</sup>  
*MOTORCYCLES*

*ON-E*  
K I D S

**TRS Motorcycles**

Ronda Sant Pere 306, Polígon les Verges, 08251

Santpedor (Barcelona, Spain)

[info@trsmotorcycles.com](mailto:info@trsmotorcycles.com)

[www.trsmotorcycles.com](http://www.trsmotorcycles.com)

You could browse our website to order spare parts or accessories, be informed of news and find other interesting information.

**TRS**